



THE ROBUST WASTEWATER GRINDER

**XRipper® with monolithic Ripper rotors
for maximum efficiency**

VOGELSANG – LEADING IN TECHNOLOGY



XRipper® XRP



XRipper® XRC-SIK

RELIABLE PROTECTION AGAINST CLOGGING AND BLOCKAGES!

The powerful and robust
XRipper® series twin-shaft
shredder by Vogelsang

Twin-shaft shredder by Vogelsang, based on monolithic Ripper rotors, reliably reduces entangled materials in digesters and sewers, as well as fibrous disruptive matter, textiles, sanitary items and other rubbish in wastewater, thereby protecting downstream equipment from clogging and malfunctions.

It's a serious and expensive problem for many municipalities and wastewater treatment organizations: frequent blockages of pipes, pipeline systems and pumping stations caused by wet wipes and other sanitary items and textiles disposed of in the toilet. In conjunction with the (fortunately) lower water consumption, the way products from drugstores are being handled in modern life is leading to considerable difficulties. Entangled materials from digesters are also repeatedly causing malfunctions in plant operations. Both of these issues create additional work and enormous costs for operators of sewage treatment plants and sewer networks.

One solution already used worldwide is the XRipper wastewater shredder by Vogelsang. As frequent malfunctions are time-consuming and onerous, investment in this twin-shaft shredder built from premium-quality, highly resistant material, will lead to a fast return on investment; the robust machine has proven time and time again that it can reduce the number of (emergency) maintenance visits required. Many customers have reported a 100 % success rate, with no further clogging issues.



Entangled materials from wet wipes and fibers cause clogging and operational disruptions.

Speak with our specialists today to find out which XRipper version is best for your needs.

Advantages of the XRipper® at a glance

- Economical shredding of solid and disruptive matter such as wet wipes, wood, fabric, trash and waste
- Efficient protection for pumps and system components from clogging, blockages and damage
- Long service life thanks to rugged design
- Fast access to all individual parts yet less service and maintenance work
- Added reliability thanks to cartridge mechanical seal technology

With its tried-and-tested twin shaft version, the XRipper has proven to be a resilient, economical solution for reducing disruptive matter to a manageable size. In this way it protects downstream components and units from clogging, blockages and damage.

The principle

The Ripper rotors of the XRipper, with their one-piece construction, are installed so that they intermesh. Whereas water will pass by the XRipper more or less unobstructed, solid and disruptive matter, such as sanitary products, wood, fabric or waste from food production, is detected by the XRipper rotors and shredded to a manageable size.

Another important factor is that the Ripper rotors clean themselves due to their different speeds.

For greater power and efficiency

To attain maximum force transfer from shaft to the cutting elements, the monolithic Ripper rotors are manufactured from a single block of special steel or, optionally, from stainless steel. This leads to hard and precise cutting and thus an optimized cutting effect.

Safe, easy to maintain and cost-efficient

The monolithic design of the Ripper rotors not only ensures particularly thorough shredding and fault-free flow of the treated wastewater, but it also has a positive effect on economic efficiency when it comes to maintenance of the shredder. This is due because, rather than lots of individual cutting rings and spacers, only the one piece rippers, need to be replaced. This simplifies assembly to save time and ensures greater safety.

All other service and maintenance work, such as the replacement of seals, can be performed on-site quickly. Here too, fully preinstalled cartridge mechanical seals are used, which can be replaced in their entirety, increasing the XRipper's already high level of availability even further.



PASS EVERY RIPPING TEST

The one-piece Ripper rotors of the XRipper® series offer outstanding shredding performance

Unique design

Due to the great forces generated in the particularly challenging shredding processes used in sewers and wastewater treatment plants, robust machine design and construction is a high priority. For this reason, high-precision CNC machines are used to manufacture each of the one-piece Ripper rotors by Vogelsang from a single block of special steel. The unique design has a high-strength core, especially narrow gaps and hardened, durable cutting edges. Even without the carrier shafts which usually run through the entire unit, the drive output is transferred evenly along the entire length of the monolithic rotors. Intermediate bearings are not necessary thanks to the high bending stiffness. Moreover, the most advanced production methods also ensure minimum tolerances, so highly efficient shredding can also be guaranteed over the long term.

Another advantage of this unique design – easy part replacement! Instead of exchanging many individual disks and spacers on the carrier shafts, only the one-piece Ripper rotors need to be replaced. Due to the symmetrical design, they can also be rotated 180 degrees. In addition, on the XRP, XRC and XRG models, the entire functional unit – which consists of the motor, gearbox, Ripper rotors and counter bearings – can simply be lifted out of the housing in one piece. The housing remains in place while all of the parts that are important for service and maintenance are easy to access.



The monolithic one-piece Ripper rotors are extremely rigid and especially easy to maintain

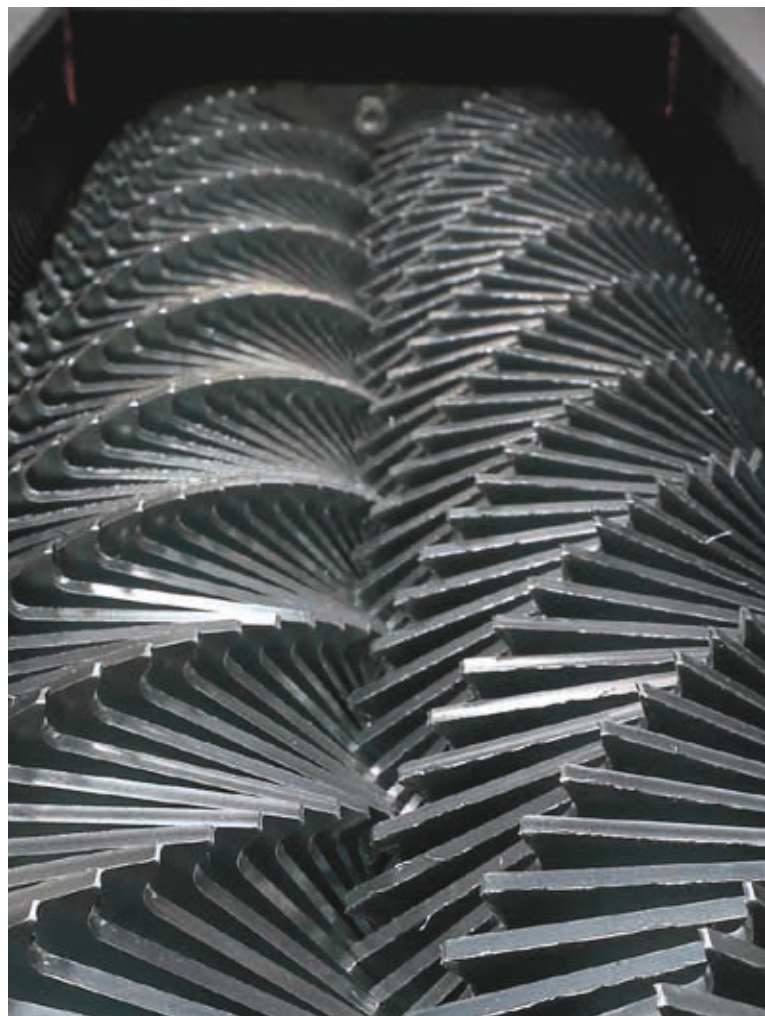

A TRIED AND TESTED ALL-ROUNDER WITH MANY QUALITIES

The unrivaled, easy-to-maintain and highly adaptable XRipper® XRS for demand- optimized installation

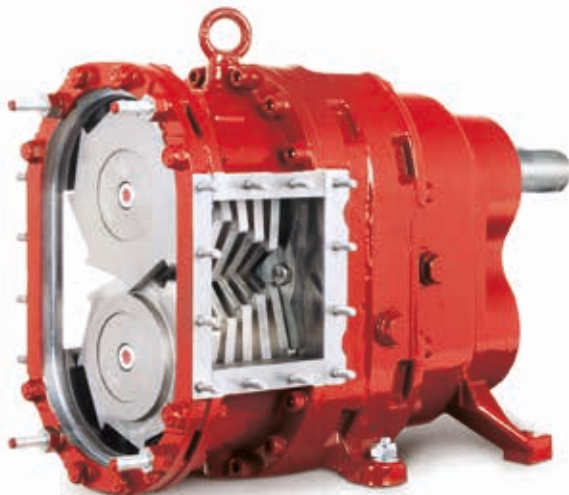

The combination of powerful shredding, easy-to-maintain design and long service life has made the XRipper XRS a reliable fixture in industry, production plants and sewage treatment plants. It reliably shreds entangled materials in sewage treatment plants: sanitary items, textiles and clothing in the wastewater of mixed sewers as well as bones, fruit, vegetables and food remnants in industrial and commercial applications.

Versatile and adaptable

The XRipper XRS owes its versatility among potential applications to the many options and material alternatives that can be incorporated in its construction. For instance, the housing can be made from cast iron, steel or stainless steel, while shredder rotors are available in specialized steel or stainless steel. Optional connector boxes separate heavy material upstream from the XRipper XRS. Drive power is provided by geared motors or parallel shaft geared motors, connected to the XRipper either directly or via a coupling.

Durable and time-saving

Regardless of the version selected, with an XRipper XRS, you can rely on reliable solids reduction and efficient protection from disruptive matter while enjoying maximum ease of maintenance. Thanks to the QuickService design typical of Vogelsang products, the shredder tools can be easily accessed with just a few hand motions. All maintenance work and the replacement of all wearing parts can be accomplished rapidly and with ease – with no need to disassemble the XRipper XRS from the pipe.

Advantages of the XRipper® XRS

- Easy to maintain thanks to the QuickService design
- Versatile thanks to comprehensive range of features and options
- Economical processing of solids and reliable protection from disruptive matter

EASY TO MAINTAIN COMPACT MIRACLE FOR DEMANDING APPLICATIONS

The space-saving XRipper® XRP
for full-size performance
in the smallest of spaces



Pumping stations and collection shafts are not large working spaces. Space everywhere is at a premium, maintenance teams have hardly any room to maneuver and there isn't much air left for the installation of additional machines for wastewater pretreatment.

The XRipper XRP delivers reliable protection from clogging with minimal space requirement: a twin-shaft shredder with the motor arranged vertically above the grinder and extremely low space requirement from flange to flange. Furthermore, the inline arrangement where inlet and outlet are directly opposite one another facilitates retrofit installation.

Slimmed-down design and maintenance

Like all XRippers, the wastewater mostly flows unhindered through the generously dimensioned, specially designed housing of the XRP while wet wipes, textiles, waste and entangled materials are systematically reduced to a manageable size by the Ripper rotors.

Here as well, the practical design concept allows quick and easy maintenance and part replacement: The complete functional unit – drive motor, gearbox, shafts and Ripper rotors – can be lifted up and out of the XRP, thanks to its vertical design.

Efficient protection with low power requirements

The XRipper XRP requires very little drive power to reliably protect the downstream components. At low speed, high torque is available for shredding disruptive matter. The Ripper rotors reliably shred virtually all disruptive matter. Directly coupled parallel shaft geared motors designed to IP55 provide the drive power. Optionally, in the case of submersed operation, submersible motors can be used.

Advantages of the XRipper® XRP

- Vertical, space-saving "inline" installation in the tightest of spaces
- Efficient and reliable protection thanks to high torque
- Easy to maintain thanks to straightforward access to the functional unit

The right twin-shaft grinder for every application site

XRipper® XRS

The versatile, easy-maintenance series

The XRipper XRS is the cost-effective solution for reducing solids and impurities in municipal or commercial wastewater to a size, which is no longer problematic. Thanks to robust design and an extensive range of features and options, an economical solution can be found for every application. At the same time, the impressive XRS design makes service and maintenance easy: All of the required service and maintenance work can be done easily and quickly on site without having to disassemble the shredder.

- The easy-maintenance standard version with horizontal Ripper rotors
- A wide variety of adaptation options provide application flexibility

XRS100

The compact model

Max. throughput volume: 50 m³/h*

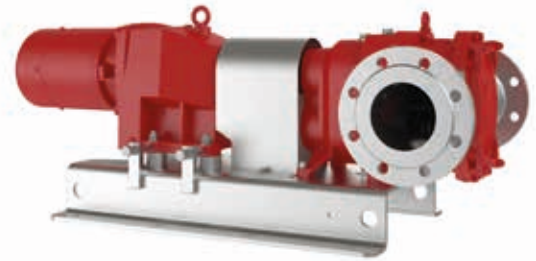

XRipper® XRP

The compact in-line variant for pipe systems

The XRP offers reliable shredding performance in the smallest of spaces. Because the motor is mounted above the XRipper, the required footprint is minimal, so the XRP can be installed even in the narrowest shafts. At the same time, the clever concept provides simple access for required service and maintenance work: The entire functional unit is simply lifted out while the housing remains securely affixed in the pipe system.

- Twin-shaft shredder with minimal installation depth, vertical rotors and a motor installed above them
- Suitable for in-line applications in pipe systems with particularly tight dimensions

XRP100

The economical and compact mode

Max. throughput volume: 85 m³/h*



* Maximum theoretical throughput with water and a pressure loss of 0.25 bar (XRS) or 0.15 bar (XRP). With our computer-assisted design software, we can configure the optimum shredder for your application

XRS136

The mid-size solution

Max. throughput volume: 110 m³/h*



XRS186

The high-performance model

Max. throughput volume: 325 m³/h*

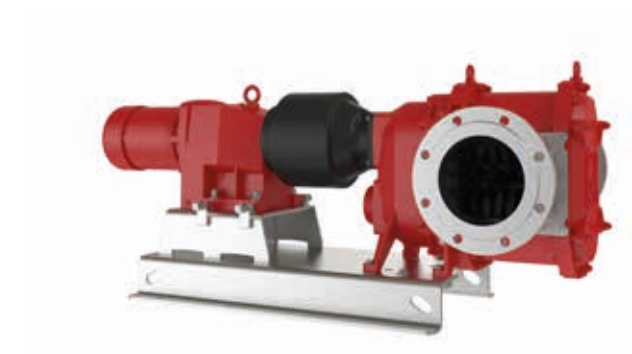

XRP136

The universal in-line variant

Max. throughput volume: 300 m³/h*



XRP186

The high-throughput model

Max. throughput volume: 1,140 m³/h*



MOVABLE, NARROW UNIT KEEPS EVERYTHING FLOWING

**The high-throughput XRipper® XRC-SIK
for open sewage channels, inflow and
supply flow structures**

Installing shredders directly in the closed pipeline of a wastewater system is one option. Another effective measure to protect against disruptions is to install a shredder in open sewage channels, or inflow or supply flow structures of pump sumps and collection shafts.



Because of its position, the shredder should be as free as possible from interruptions and have a low-maintenance requirement – challenges that the robust and flow-optimized XRipper XRC-SIK successfully meets. Its design with bearings on both sides ensures interruption-free shredding, even with the most coarse disruptive matter (such as cleaning rags, wood, garbage, clothes or sanitary items), while the wastewater flows largely unimpeded through the large housing. This ensures that wastewater drains off reliably without causing blockages, clogging or damage to downstream pumps and fittings.

Runs on rails

To simplify installation and maintenance, the XRipper XRC-SIK is mounted on a Sewer Integration Kit (SIK) before leaving the factory. This system of rails is used to position the XRipper directly in the sewer or in front of its inlet or outlet. When maintenance is required, the response team simply pulls the shredder out of the sewer via the rail system, using a crane. The SIK is also designed to allow simple installation against slanted or round walls.

Like all XRippers, replacement of the monolithic Ripper rotors and seals is performed rapidly: On the XRC-SIK as well, simply remove the cover for free access to all components, with no need to disassemble the drive beforehand.

Application-specific and energy-efficient drive

The parallel shaft geared motor with IP55 protection rating is just as compact as the shredder itself. Floodable or flooded submersible motors are available for the XRC-SIK. Low speeds and high torque give the Ripper rotors outstanding force at relatively low drive power.

Advantages of the XRipper® XRC-SIK

- Extremely compact design
- Simple removal and positioning with the Sewer Integration Kit (SIK)
- No need for fastening hardware or work

POWERFUL GIANT

The XRipper® XRG
for maximum flow rates



High flow rates, such as those occurring in large sewers and inflows of sewage treatment plants, can only be mastered with appropriately large yet efficient shredders. This is the only way to reliably catch and grind all disruptive matter contained in the wastewater, in order to reliably protect downstream systems from clogging and blockages.

The principle

The XRipper XRG was developed specifically for these applications. The sieve drums of the High Capacity Units arranged laterally in the housing permit large quantities of (waste)water to pass by unhindered, while catching and holding back the disruptive matter and waste. This is continuously fed into the Ripper rotors by the separately driven, slow-rotating yet powerful High Capacity Units, where it is shredded to a manageable size.

Individual drives for each function

The Ripper rotors and High Capacity Units of the XRipper XRG are driven independently of one another. This allows optimal adaptation to their respective tasks, with no need for extra power transmission components. This also simplifies removal of the functional unit – removal of a couple of screws on the housing is all that is required. Simultaneously, each drive can be individually monitored. The corrective measures to be taken in the event of an interruption are specifically oriented to that part of the shredder, while the rest of the machine continues to do its job.

Advantages of the XRipper® XRG

- Monolithic one-piece Ripper rotors
- High flow rates
- Reliable separation and shredding of disruptive matter
- On-site service and maintenance

The right twin-shaft grinder for every application site

XRipper® XRC-SIK

The user-friendly variant for open channels and shafts

The XRC is the optimum choice for installation in open sewage channels or for mounting in inflow or supply flow structures in shafts and trenches. With the flexible Sewer Integration Kit (SIK) rail system, it can be easily positioned in open channels or against slanted or even rounded walls directly in front of the inlet or outlet. For maintenance and service, the SIK is used to lift the entire shredder out of the channel, shaft or pit.

- Easy positioning and removal with the SIK
- Suitable for large throughput volumes, e. g., in sewage channels and in inflow or supply flow structures

XRC100

The extra narrow model

Max. throughput volume: 690 m³/h*



XRipper® XRG

The giant model for maximum flow rates

The XRG provides reliable and highly efficient protection from solids and impurities in wastewater at extremely high flow rates, e. g., in large channels and inflows for sewage treatment plants. The laterally arranged High Capacity Units allow the unimpeded flow of large volumes of (waste-) water. Impurities and contaminants are retained and conveyed continuously to the Ripper rotors which shred them down to a size which is no longer problematic.

- Twin-shaft shredders for extremely high flow rates thanks to the High Capacity Units
- Reliable separation and shredding of impurities

XRG100

The slim champion

Max. throughput volume:
1,164 m³/h*



* Maximum theoretical throughput with water and optimum channel conditions. With our computer-assisted design software, we can configure the optimum shredder for your application.

XRC136

The universal model

Max. throughput volume: 940 m³/h*



XRC186

The high-performance model

Max. throughput volume:
1.770 m³/h*



XRG136

The universal model with flow enhancer
on one or both sides

Max. throughput volume:
3,300 m³/h*



XRG186

The high-throughput
champion

Max. throughput volume:
7,164 m³/h*



WHEN IT COMES TO SERVICE, WE LEAVE NOTHING TO CHANCE

Comprehensive services for smooth operation and a long lifetime

Support and supply from A to Z

Because we are aware that close customer proximity is essential for our mutual success, we design our services to best meet your needs. In Germany and in countries where we have subsidiaries, Vogelsang service centers and contractual partners generate an active dialog with our customers and provide reliable support.

This means you always get the precise support you need in every phase of our partnership. Our highly qualified staff make it possible – experts such as consultants and technicians who know your Vogelsang machines inside and out.



Since its establishment in 1929, Vogelsang has become an internationally recognized mechanical engineering company with numerous branches, sales centers and subsidiaries.



We think ahead

Thinking ahead in your best interest begins with our extensive and detailed product documentation. Spare parts are available within a short time due to our high degree of vertical integration in production. In addition, you will always find an authorized service partner in your area who can help with repairs and wear part replacement. The Vogelsang ServicePack completes the offer. Whether you need start-up, on-site training, training at the Vogelsang facility, or full service support with a maintenance contract and a wear parts service package – we offer a support program tailored specifically to your needs.

What we offer

We provide solutions in the following sectors:
AGRICULTURAL TECHNOLOGY, BIOGAS,
INDUSTRY, TRANSPORTATION, WASTEWATER



Our broad range of products and services

- Consulting and service
- Data management and control technology
- Disintegration technology
- Individually tailored solutions for special applications
- Pumps and pump systems
- Solid matter feeders
- Solids reduction, separators and mixers
- Spreading technology
- Supply, disposal and cleaning

Copyright 2023 Vogelsang GmbH & Co. KG

Product availability, appearance, technical specifications and details are subject to continuous development. All information presented here is therefore subject to change.

In selected countries, Vogelsang®, BioCrack®, BioCut®, BlackBird®, CC-Serie®, EnergyJet®, HiCone®, PreMix®, RotaCut®, XRipper®, XSplit® and XTill® are registered trademarks of Vogelsang GmbH & Co. KG, Essen (Oldenburg), Germany. All rights reserved, including the rights to all graphics and images.

The robust wastewater grinder_EN_06207723_MET1148 – Printed in Germany

Vogelsang GmbH & Co. KG
Holthoeye 10 – 14 | 49632 Essen (Oldenburg) | Germany
Phone: +49 5434 83 - 0 | Fax: +49 5434 83 -10
germany@vogelsang.info

[vogelsang.info](https://www.vogelsang.info)





SPECIFICATION

THE ROBUST WASTEWATER GRINDER

XRipper[®] with monolithic Ripper rotors
for maximum efficiency

VOGELSANG – LEADING IN TECHNOLOGY

VOGELSANG



XRipper[®] XRS

The versatile and easy to maintain series

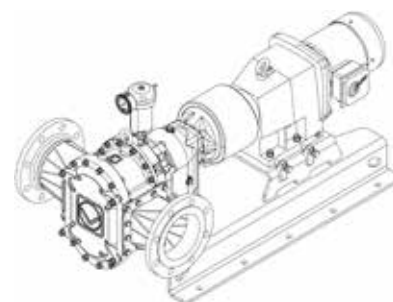

Type	Blade widths	Drive power	Drive speed	Max. throughput*	Max. pressure	Flange connector
	mm	kW	min ⁻¹	m ³ /h	bar	mm
100 - 90Q	5.5/7.4	1.5	53	50	8	Ø 100
136 - 140Q	6.2/9.8	2.2	41	110	8	Ø 150
186 - 130Q	7.9/10.6	4.0	40	165	8	Ø 150
186 - 260Q	7.9/10.6	4.0	40	325	6	Ø 200

* Maximum theoretical throughput for water and a pressure loss of 0.25 bar. We would be happy to configure the best grinder for your application with the help of our computer-assisted design software.

XRipper[®] XRG

A giant for maximum flow rates

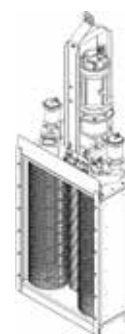

Type	Blade widths	Drive power	Drive speed	Drive power High Capacity Unit	Max. throughput*	Width
	mm	kW	min ⁻¹	kW	m ³ /h	mm
100 - 480QD + HCS	5.5	2.2	50	1 x 0.25	496	530
100 - 640QD + HCS	5.5	2.2	50	1 x 0.25	658	530
100 - 800QD + HCS	5.5	2.2	50	1 x 0.25	892	530
100 - 960QD + HCS	5.5	2.2	50	1 x 0.25	1,164	530
136 - 560QD + HCS	9.8	4.0	45	1 x 0.25	883	740
136 - 560QD + HCD	9.8	4.0	45	2 x 0.25	1,218	1,067
136 - 840QD + HCS	9.8	4.0	45	1 x 0.25	1,326	740
136 - 840QD + HCD	9.8	4.0	45	2 x 0.25	1,778	1,067
136 - 1120QD + HCS	9.8	4.0	45	1 x 0.25	1,794	740
136 - 1120QD + HCD	9.8	4.0	45	2 x 0.25	2,419	1,067
136 - 1400QD + HCS	9.8	4.0	45	1 x 0.25	2,431	740
136 - 1400QD + HCD	9.8	4.0	45	2 x 0.25	3,300	1,067
186 - 780QD + HCD	9.8	5.5	37	2 x 0.55	2,738	1,370
186 - 1040QD + HCD	9.8	5.5	37	2 x 0.55	3,597	1,370
186 - 1300QD + HCD	9.8	5.5	37	2 x 0.55	4,727	1,370
186 - 1560QD + HCD	9.8	5.5	37	2 x 0.55	5,920	1,370
186 - 1820QD + HCD	9.8	5.5	37	2 x 0.55	7,164	1,370

* Maximum theoretical throughput for water and optimale sewer conditions. We would be happy to configure the best grinder for your application with the help of our computer-assisted design software.

XRipper[®] XRP

The compact inline variant for pipe systems

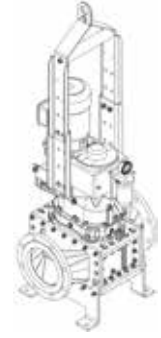

Type	Blade widths	Drive power	Drive speed	Max. throughput*	Max. pressure	Flange connector	Installation width Flange to flange
	mm	kW	min ⁻¹	m ³ /h	bar	mm	mm
100-90Q	5.5/7.4	1.5	57	85	8	Ø 100	406
136-140Q	6.2/9.8	2.2	46	165 190	8	Ø 100 Ø 150	406 483
136-200Q	5.9/9.5	2.2/4.0	46/45	265 280 300	6	Ø 100 Ø 150 Ø 200	488 540 590
186-260Q	7.9/10.6	4.0	38	490 550	4	Ø 250 Ø 300	692 794
186-520QD	7.9/10.6	4.0/5.5/7.5	38/36/41	980 1,060 1,140	4	Ø 300 Ø 400 Ø 450	895 1,099 1,200

* Maximum theoretical throughput for water and a pressure loss of 0.15 bar. We would be happy to configure the best grinder for your application with the help of our computer-assisted design software.

XRipper[®] XRC mit SIK

The user-friendly version for open sewers and ducts

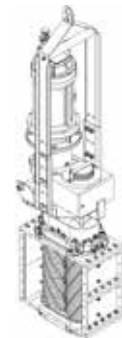

Type	Blade widths	Drive power	Drive speed	Max. throughput*	Inlet opening
	mm	kW	min ⁻¹	m ³ /h	mm (B x H)
100-320QD	5.5	2.2	50	140	219 x 320
100-480QD	5.5	2.2	50	222	219 x 480
100-640QD	5.5	2.2	50	310	219 x 640
100-800QD	5.5	2.2	50	480	219 x 800
100-960QD	5.5	2.2	50	690	219 x 960
136-280QD	9.8	3.0	44	115	365 x 280
136-560QD	9.8	3.0	44	360	365 x 560
136-840QD	9.8	3.0	44	625	365 x 840
136-1120QD	9.8	3.0	44	940	365 x 1,120
186-260Q	9.8	4.0	34	170	500 x 260
186-260QD	9.8	4.0	34	170	500 x 260
186-520QD	9.8	4.0	34	520	500 x 520
186-780QD	9.8	4.0	34	795	500 x 780
186-1040QD	9.8	4.0	34	1,230	500 x 1,040
186-1300QD	9.8	4.0	34	1,770	500 x 1,300

* Maximum theoretical throughput for water and optimale sewer conditions. We would be happy to configure the best grinder for your application with the help of our computer-assisted design software.

What we offer

We provide solutions in the following sectors:
AGRICULTURAL TECHNOLOGY, BIOGAS,
INDUSTRY, TRANSPORTATION, WASTEWATER



Our broad range of products and services

- Consulting and service
- Data management and control technology
- Disintegration technology
- Individually tailored solutions for special applications
- Pumps and pump systems
- Solid matter feeders
- Solids reduction, separators and mixers
- Spreading technology
- Supply, disposal and cleaning

Copyright 2023 Vogelsang GmbH & Co. KG

Product availability, appearance, technical specifications and details are subject to continuous development. All information presented here is therefore subject to change. In selected countries, Vogelsang®, BioCrack®, BioCut®, BlackBird®, CC-Serie®, EnergyJet®, HiCone®, PreMix®, RotaCut®, XRipper®, XSplit® and XTill® are registered trademarks of Vogelsang GmbH & Co. KG, Essen (Oldenburg), Germany. All rights reserved, including the rights to all graphics and images.

The robust wastewater grinder_TD_EN_06207723_MET1149 - Printed in Germany

Vogelsang GmbH & Co. KG
Holthoeye 10 – 14 | 49632 Essen (Oldenburg) | Germany
Phone: +49 5434 83 - 0 | Fax: +49 5434 83 -10
germany@vogelsang.info

vogelsang.info

